

BOP HANDLING SYSTEM

25 to 250 Metric Tons Capacity

THE OIL & GAS INDUSTRY

For over 50 years, Ingersoll Rand® has designed, manufactured, and serviced hundreds of Blowout Preventer (BOP) Handling Systems for all the major drilling contractors and oil companies in the industry.

Our familiarity with this complex and critical lifting application enables us to provide the type of equipment, engineering support, and certifications that these projects require.



BOP HANDLING SYSTEMS

Our BOP Handling Systems are designed to meet or exceed the specifications of one or more of the following regulatory bodies:

The Norwegian Petroleum Directorate (NPD), UK HSE, Lloyds Register of Shipping (LRS), Der Norske Veritas (DNV), and American Bureau of Shipping (ABS) for the oilwell drilling industry.

All Ingersoll Rand BOP Handling Systems are designed and built in ISO9001: 2015 certified factories.



CE marked models are compliant with the latest European machinery directive No 2006/42/EC and the European standard for Power Driven Hoists EN 14492-2. These models include as standard an emergency stop on pendent and main air shut-off valve as per ISO 13850 standard, an overload protection and a CE declaration of conformity.



The BS and BHS BOP handling systems are particularly suitable for use in potentially explosive atmospheres. In their standard design, they are classified as equipment category 3 for applications in zone 2 as per ATEX 2014/34/EU Directive (ATEX marking II 3 G Ex h IIB T4 Gc). For more hazardous areas such as zone 1, they are offered with a special spark resistant package (ATEX marking II 2 G Ex h IIB T4 Gc).

MODULAR CONCEPT

Our tough systems feature a new modular “platform” design that can accommodate either gear or piston air motors, as well as hydraulic versions. Find the right headroom size, choose your bottom attachment and control type, Ingersoll Rand engineers designed this concept to make things simple for you.

This modular design combined with our commitment to safety and quality allows us to provide our clients with the safest and most cost-effective solutions possible, with shorter delivery times.

Beam Profile Selection

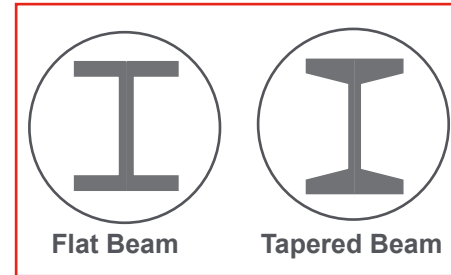

Trolley Selection

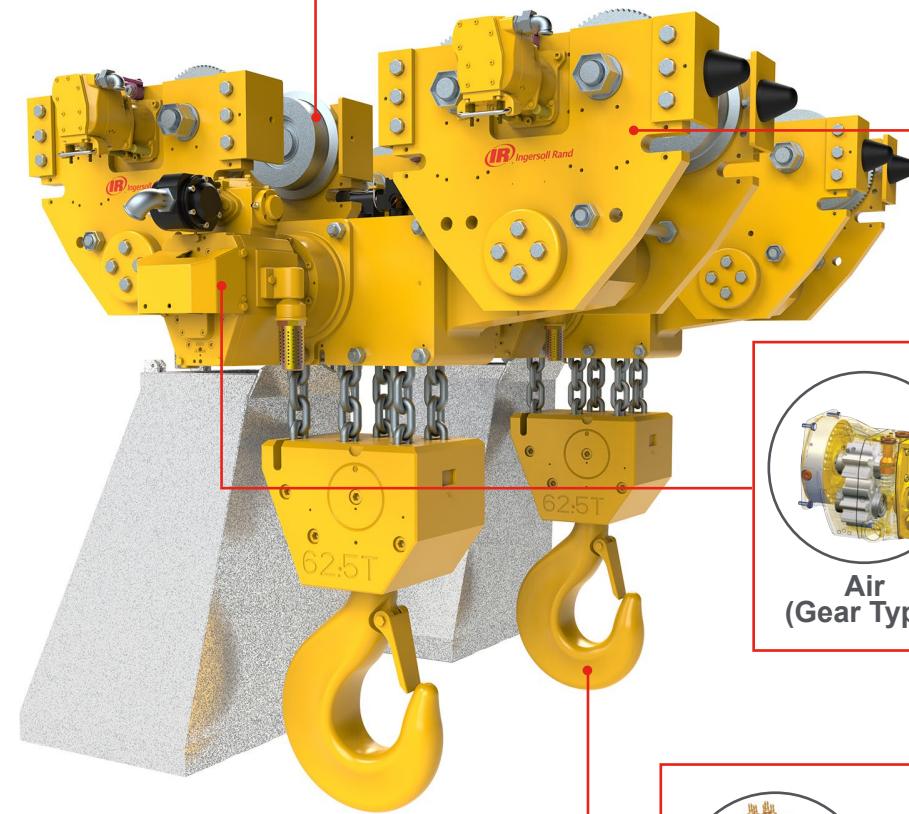
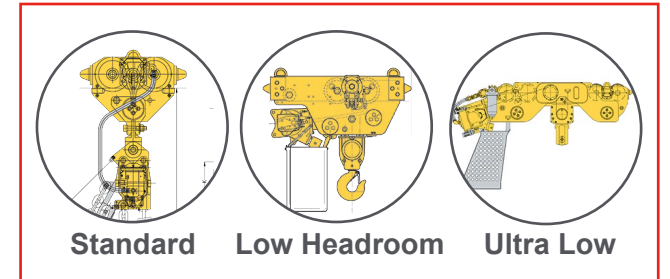

Motor Selection

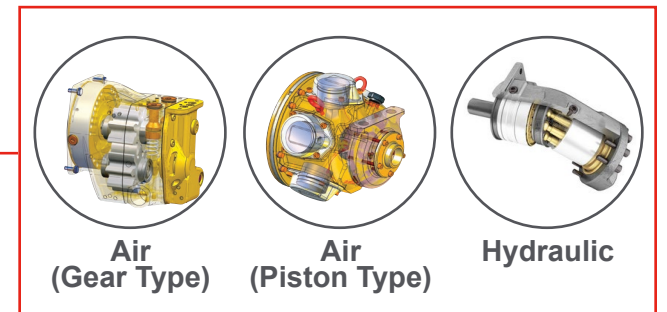

Control Selection

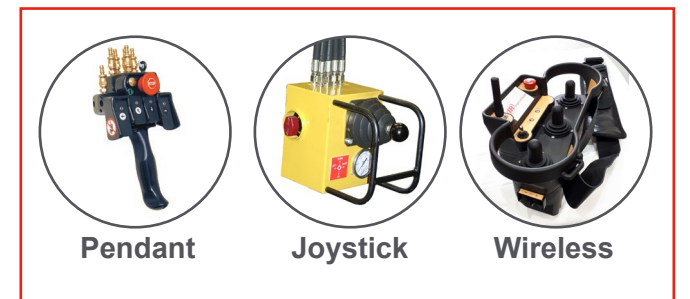

Attachment Selection

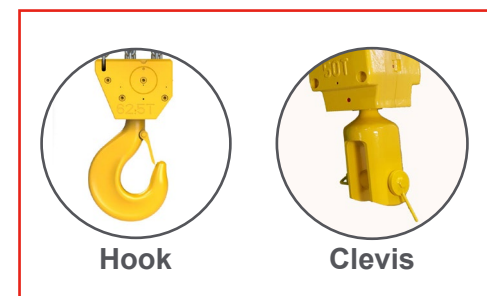

STANDARD FEATURES

ALL MODELS

- All steel/cast iron construction
- 5:1 design factor on load bearing parts
- Group Mechanism: FEM 1Bm (ISO M3)
- -20°C design temperature
- Automatic Fail Safe multi disc brake on hoist and trolley (Self-locking worm drive gear box on BHS trolley)
- Fully enclosed planetary gear box
- Articulated trolley allowing side pulling operations of + / - 20° (not available on LBS and ULBS series)
- Trolley side guide rollers, rubber bumpers and rail sweeps
- Grade 80 load chain as per EN 818-7
- 9 meter height of lift
- Bottom block equipped with water drain hole and bearing greaser
- Alloy steel hook as per DIN15401 with safety latch
- Galvanized steel chain container
- Lifting lugs for ease of installation

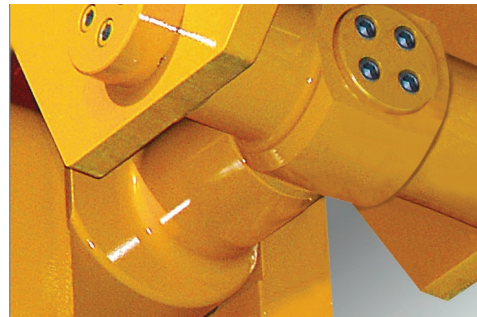

Trolley Articulation

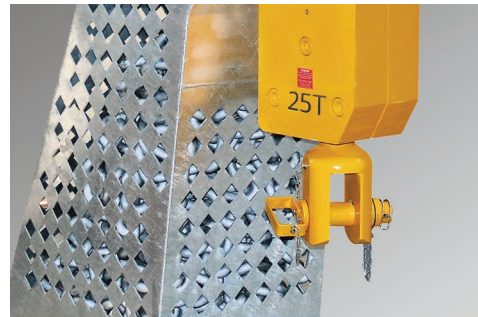

Chain Container

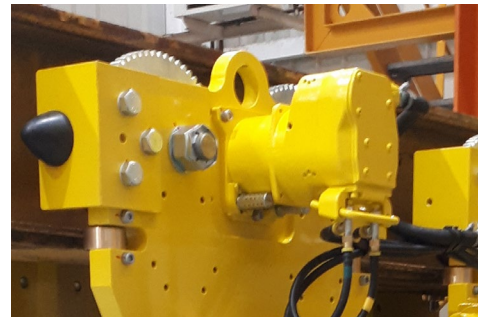

Trolley Guide Rollers, Bumpers and Sweeps

SAFETY

Ingersoll Rand® BOP systems are equipped with an articulation* between the trolley and the hoist body to prevent any excessive stress during lifting operations when supporting beams are not fully aligned with the BOP lifting lugs*

* Not available on LBS and ULBS

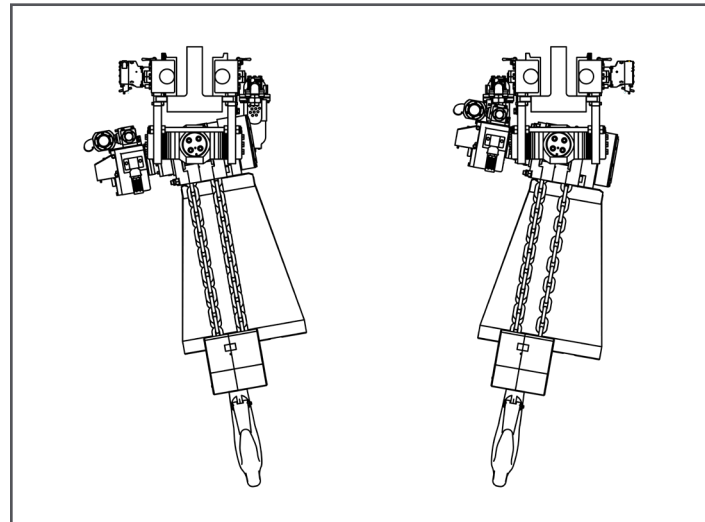

STANDARD FEATURES

SPECIFIC TO AIR OPERATED SYSTEMS

- 2 motors “PHS” variable speed pendant control (one per hoist)
- 9 meter of control drop
- Pneumatic limit switches for over-travel protection
- Filter-Regulator-Lubricator mounted on trolley flange
- Exhaust mufflers

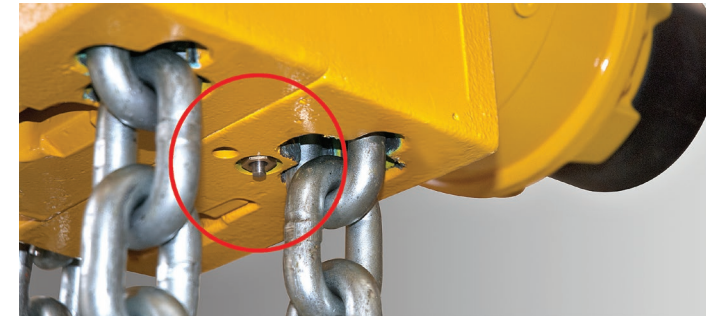

Built-in Limit Switches



PHS Pendant with Emergency Stop Option

RELIABILITY

Ingersoll Rand® air operated BOP systems are fitted with an air treatment package composed of a filter-Regulator- Lubricator in order to ensure proper air quality for a long life cycle and reduced downtime.



SPECIFIC TO HYDRAULIC OPERATED SYSTEMS

- Choice of Full flow or Joystick remote control
- Counter-balance valve
- 9 meter of control drop (joystick control)



Hydraulic Joystick Control



Counter Balance Valve

STANDARD FEATURES

CORROSION PROTECTION

- Corrosion resistant load chain
- Corrosion resistant Marine paint
- Corrosion resistant bolting (Stainless steel up to M10, hot dip galvanized > M10)

TESTING

- Test at nominal load of speeds and controls
- Dynamic test at 110% of Safe Working Load
- Brake Static test at 125% of SWL
- Adjustment of overload protection as per EN14492-2 (CE certified models only)

DOCUMENTATION

- Test Reports, Technical Datasheets
- Installation and safety manual in multiple languages
- Spare parts manual (English only)
- Instruction manual (English only)
- CE and ATEX certificate (CE certified models only)

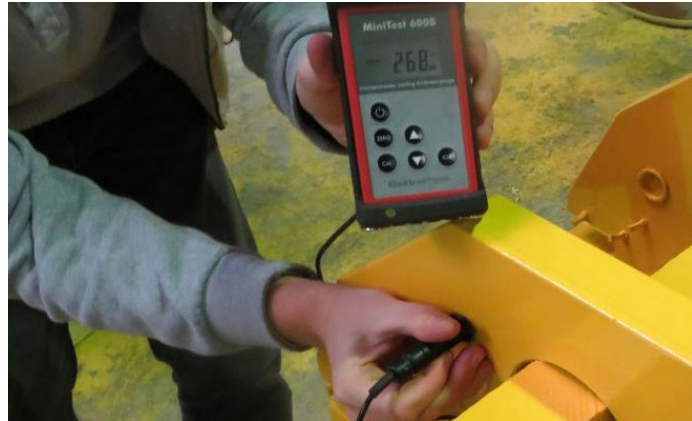

Dry Film Thickness Control

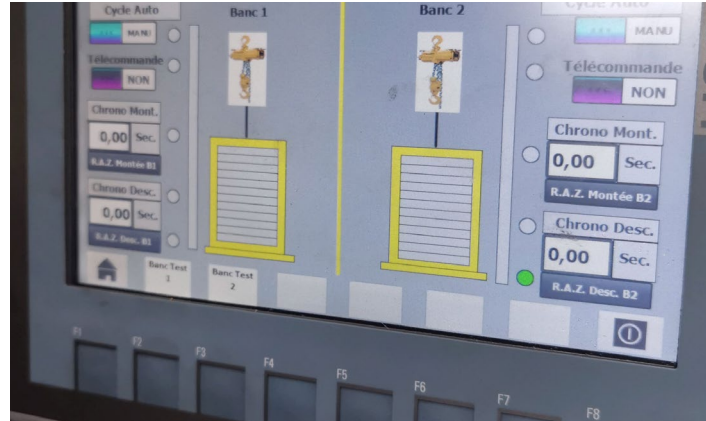

Test Tower Control Display



Clevis Attachment
(Optional Feature)



Bronze Coated Bottom Hook
(Optional Feature)

OPTIONAL FEATURES

OPTIONAL FEATURES

- Rack and pinion trolley drive
- 3.1 Material Traceability certificates on main load bearing parts as per EN10204
- Clevis instead of bottom hook attachment
- Sandblasting and offshore 3 layers paint system ISO C5-M
- Trolley limit switches
- Spark resistance package for ATEX zone 1 use (includes trolley solid bronze wheels, bronze coated bottom block and hook, cast iron PHS pendent)
- Third party witness of factory test (ABS, DNV, LLOYD'S)



VERSATILITY

When harsh conditions are met in offshore operation, our Rack and pinion drive system offers a positive engagement. Rack sections of 1,5 meter long have to be welded on the travel beam. The positioning underneath the beam flange prevents dust contamination and ensure long life.



BS SERIES GEAR AIR MOTOR

Gear motors have only two moving parts, which reduces the complexity of motor maintenance. The high torque feature provides outstanding control at low speed. Gear motors will better tolerate the wet and dirty air supply than any other technologies.

- Gear type air motor on hoist and trolley
- 5:1 design factor
- Group Mechanism: FEM 1Bm (ISO M3)
- All steel/cast iron construction
- -20°C design temperature (optional)
- Automatic Fail Safe multi disc brake on hoist and trolley
- Articulated trolley allows side pulling operations
- Fully enclosed planetary gear box
- Control by progressive remote "PHS" pendant

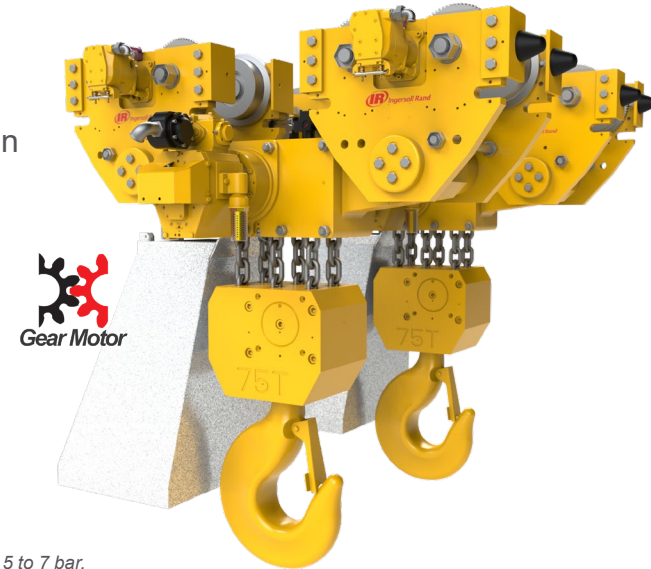

Specifications at 6.3 bar dynamic pressure (while hoists motors are running) - Working Pressure 5 to 7 bar.

BS GEAR MOTOR SERIES - HOIST SUB-ASSEMBLY

MODEL	System Capacity (T)	Falls of Load Chain Per Hoist	Min. Headroom (mm)	Lifting Speed at Rated Load (m/min)	Lifting Speed at No Load (m/min)	Lowering Speed at Rated Load (m/min)	Motor Power per Hoist (hp)	Air Consumption at Rated Load (m³/min)	Air Inlet Size BSP	Sound Pressure ⁽¹⁾ (dbA)	System Weight ⁽²⁾ (kg)	Chain Size (mm)
BS25LC2A2	25	2	1135	1	1.8	1.3	6	5.0	1"	79	950	16x45
BS30LC2A3	30	3	1210	0.8	1.2	0.9	6	5.2	1"	79	1650	16x45
BS36LC2A3	36	3	1210	0.7	1.2	0.9	6	5.2	1"	79	1650	16x45
BS40LC2A4	40	4	1240	0.6	0.9	0.6	6	5.0	1"	79	1800	16x45
BS50LC2A4	50	4	1240	0.5	0.9	0.6	6	5.0	1"	79	1800	16x45
BS50LC2A2	50	2	1043	1.6	3	2.5	10	12	1-1/2"	93	3260	22x66
BS75LC2A3	75	3	1190	1.1	2	2	10	12	1-1/2"	93	4000	22x66
BS100LC2A4	100	4	1232	0.8	1.5	1.5	10	12	1-1/2"	93	4200	22x66
BS125LC2A5	125	5	1385	0.64	1.2	1.2	10	12	1-1/2"	93	6000	22x66
BS150LC2A6	150	6	1520	0.53	1	1	10	12	1-1/2"	93	6400	22x66
BS150LCA3	150	3	1865	0.35	0.65	0.6	10	12	1-1/2"	93	13000	32x90
BS200LCA4	200	4	1960	0.25	0.5	0.45	10	12	1-1/2"	93	13300	32x90

BS GEAR MOTOR SERIES - TROLLEY SUB-ASSEMBLY

MODEL	Number of Wheels per Hoist	Standard Flange Adjustment "X" (mm)	Max Beam Bottom Flange Thickness (mm)	Wheel Tread Diameter (mm)	Wheel Loading per Pair (kg)	Trolley Assy Length (mm)	Number of Motors per Trolley	Trolley Air Consumption per Hoist (m³/min)	Max Traveling Speed at Rated Load ⁽³⁾ (m/min)
BS25LC2A2	4	130-314	40	160	6250	622	1	1.9	12
BS30LC2A3	4	140-314	40	225	7500	782	1	1.9	15
BS36LC2A3	4	140-314	40	225	9000	782	1	1.9	15
BS40LC2A4	4	140-314	40	225	12500	782	1	1.9	12
BS50LC2A4	4	140-314	40	225	12500	782	1	1.9	12
BS50LC2A2	8	160-314	40	160	6250	1412	2	3.8	12
BS75LC2A3	8	160-314	40	225	9375	1692	2	3.8	12
BS100LC2A4	8	160-314	40	225	12500	1692	2	3.8	12
BS125LC2A5	8	160-360	102	250	15625	2060	2	3.8	9
BS150LC2A6	8	160-360	102	250	18750	2060	2	3.8	9
BS150LCA3	16	170-314	40	225	9375	3394	4	7.6	10
BS200LCA4	16	170-314	40	225	12500	3394	4	7.6	10

(1) Sound pressure levels are measured per European Standard EN14492-2
 (2) Weight of the complete system (2 hoists) with standard height of lift and length of control (9m)
 (3) In Rack & pinion configuration, the trolley speed is divided by 2

BHS SERIES PISTON AIR MOTOR



Built from the famous Liftchain series frame, the new BHS series features a performant piston air motor of 9.4hp. Very versatile, our new platform concept use the widespread Herculink™ piston motor to enrich the largest choice of BOP handling hoists in the market.

- Radial Piston type air motor on hoist and trolley
- 5:1 design factor
- Group Mechanism: FEM 1Bm (ISO M3)
- All steel/cast iron construction
- -20°C design temperature
- Automatic Fail Safe multi disc brake on hoist
- Trolley brake: Self-locking worm drive gear box
- Articulated trolley allows side pulling operations
- Fully enclosed planetary gear box (hoist)
- Control by progressive remote "PHS" pendant

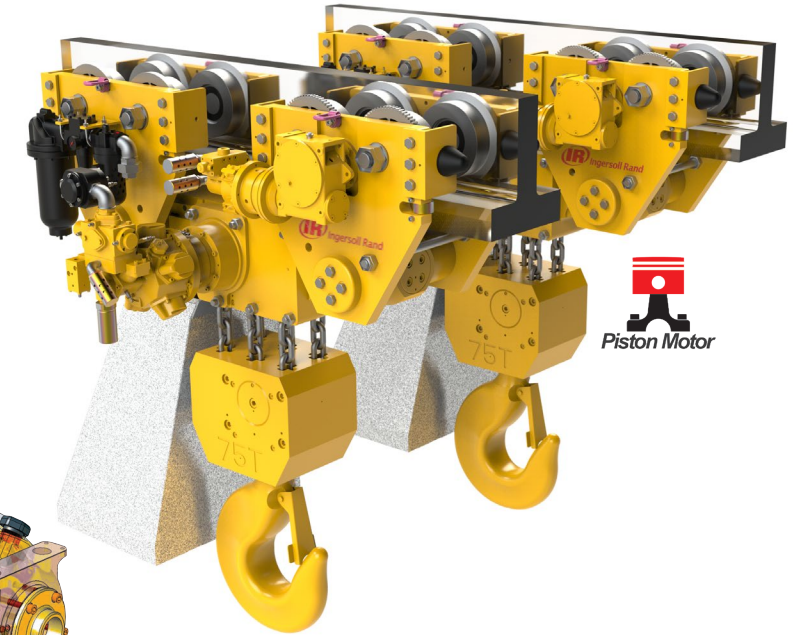

Piston motors have great lugging characteristics—that is, they allow an operator to slowly drop off a load at an inching crawl for incredible spotting.

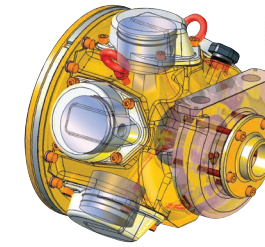

Specifications at 7.2 bar dynamic pressure (while hoists motors are running) - Working Pressure 5 to 7.2 bar.

BHS PISTON MOTOR SERIES - HOIST SUB-ASSEMBLY

MODEL	System Capacity (T)	Falls of Load Chain Per Hoist	Min. Headroom (mm)	Lifting Speed at Rated Load (m/min)	Lifting Speed at No Load (m/min)	Lowering Speed at Rated Load (m/min)	Motor Power per Hoist (hp)	Air Consumption at Rated Load (m³/min)	Air Inlet Size BSP	Sound Pressure ⁽¹⁾ (dbA)	System Weight ⁽²⁾ (kg)	Chain Size (mm)
BHS50LC2A2	50	2	1043	1.2	1.8	1.8	9.4	8	1-1/2"	105	1130	22x66
BHS75LC2A3	75	3	1190	0.8	1.2	1.2	9.4	8	1-1/2"	105	4000	22x66
BHS100LC2A4	100	4	1232	0.6	0.9	0.9	9.4	8	1-1/2"	105	4400	22x66
BHS125LC2A5	125	5	1385	0.5	0.7	0.7	9.4	8	1-1/2"	105	6000	22x66
BHS150LC2A6	150	6	1520	0.4	0.6	0.6	9.4	8	1-1/2"	105	6400	22x66

BHS PISTON MOTOR SERIES - TROLLEY SUB-ASSEMBLY

MODEL	Number of Wheels per Hoist	Standard Flange Adjustment "X" (mm)	Max Beam Bottom Flange Thickness (mm)	Wheel Tread Diameter (mm)	Wheel Loading per Pair (kg)	Trolley Assy Length (mm)	Number of Motors per Trolley	Trolley Air Consumption per Hoist (m³/min)	Max Traveling Speed at Rated Load ⁽³⁾ (m/min)
BHS50LC2A2	8	160-314	40	160	6250	1412	1	1.4	12
BHS75LC2A3	8	160-314	40	225	9375	1692	1	1.4	12
BHS100LC2A4	8	160-314	40	225	12500	1692	1	1.4	12
BHS125LC2A5	8	160-360	102	250	15625	2060	1	1.4	9
BHS150LC2A6	8	160-360	102	250	18750	2060	1	1.4	9

(1) Sound pressure levels are measured per European Standard EN14492-2
 (2) Weight of the complete system (2 hoists) with standard height of lift and length of control (9m)
 (3) In Rack & pinion configuration, the trolley speed is divided by 2

LBS SERIES GEAR AIR MOTOR

Low Headroom Models

When huge BOP stack size becomes a problem for most of standard cranes, Ingersoll Rand® Low Headroom LBS Series, can sneak in a very small space. Low profile BOP handling systems can be optioned with rack and pinion trolley drives for positive traction. A choice of various attachments offers extra space saving to tailor the product to your needs.

- Gear type air motor on hoist and trolley
- 5:1 design factor
- Group Mechanism: FEM 1Bm (ISO M3)
- All steel/cast iron construction
- -20°C design temperature
- Automatic Fail Safe multi disc brake on hoist & trolley
- Fully enclosed planetary gear box
- Control by progressive remote "PHS" pendant

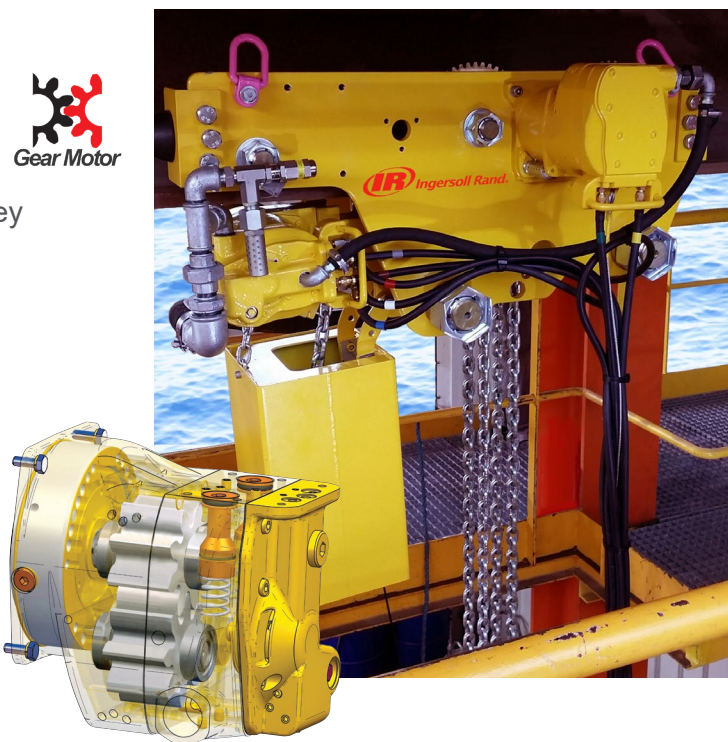

Ingersoll Rand gear air motor is characterised by:

- A unique design with only two moving parts, making it ideal for severe applications in hot, cold, dusty, dirty, explosive and wet conditions.
- A reduced sensitivity to long storage period or long period with no use.
- A low air consumption.
- A variable speed control offering a precision spotting control at slow speeds.

Specifications at 6.3 bar dynamic pressure (while hoists motors are running) - Working Pressure 5 to 7 bar.

LBS LOW HEADROOM GEAR MOTOR SERIES - HOIST SUB-ASSEMBLY

MODEL	System Capacity (T)	Falls of Load Chain Per Hoist	Min. Headroom (mm)	Lifting Speed at Rated Load (m/min)	Lifting Speed at No Load (m/min)	Lowering Speed at Rated Load (m/min)	Motor Power per Hoist (hp)	Air Consumption at Rated Load (m³/min)	Air Inlet Size BSP	Sound Pressure ⁽¹⁾ (dbA)	System Weight ⁽²⁾ (kg)	Chain Size (mm)
LBS24LC2A2	24	2	670	1.1	1.8	1.3	6	5.0	1"	79	1300	16x45
LBS36LC2A3	36	3	730	0.7	1.2	0.9	6	5.2	1"	79	1600	16x45
LBS50LC2A4	50	4	775	0.5	0.9	0.6	6	5.0	1"	79	1700	16x45

LBS LOW HEADROOM GEAR MOTOR SERIES - TROLLEY SUB-ASSEMBLY

MODEL	Number of Wheels per Hoist	Standard Flange Adjustment "X" (mm)	Max Beam Bottom Flange Thickness (mm)	Wheel Tread Diameter (mm)	Wheel Loading per Pair (kg)	Trolley Assy Length (mm)	Number of Motors per Trolley	Trolley Air Consumption per Hoist (m³/min)	Max Traveling Speed at Rated Load ⁽⁴⁾ (m/min)
LBS24LC2A2	4	140-314	40	160	6000	1164	1	1.9	15
LBS36LC2A3	4	170-314	40	225	9000	1164	1	1.9	15
LBS50LC2A4	4	170-314	40	225	12500	1164	1	1.9	15

(1) Sound pressure levels are measured per European Standard EN14492-2
 (2) Weight of the complete system (2 hoists) with standard height of lift and length of control (9m)
 (3) In Rack & pinion configuration, the trolley speed is divided by 2

ULBS SERIES GEAR AIR MOTOR

Ultra-Low Headroom Models

Ingersoll Rand® Ultra Low Profile BOP Handling Systems feature the same reliable operation and durable construction while providing even more clearance for BOP stack operation. Spark resistant, ATEX Zone 1 packages are available.

- Gear type air motor on hoist and trolley
- 5:1 design factor
- All steel/cast iron construction
- Automatic Fail Safe multi disc brake on hoist and trolley
- Fully enclosed planetary gear box

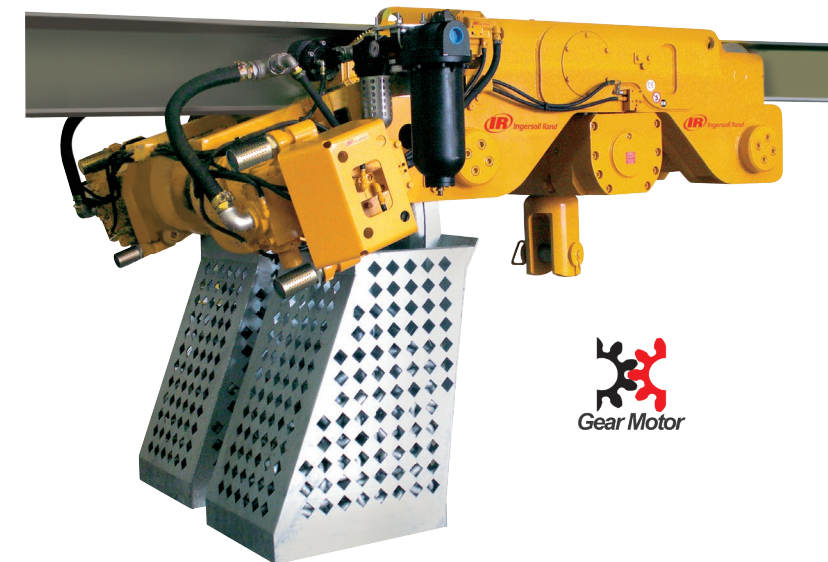

Specifications at 6.3 bar dynamic pressure (while hoists motors are running) - Working Pressure 5 to 7 bar.

ULBS ULTRA-LOW HEADROOM GEAR MOTOR SERIES - HOIST SUB-ASSEMBLY

MODEL	System Capacity (T)	Falls of Load Chain Per Hoist	Min. Headroom ⁽¹⁾ (mm)	Lifting Speed at Rated Load (m/min)	Lifting Speed at No Load (m/min)	Lowering Speed at Rated Load (m/min)	Motor Power per Hoist (hp)	Air Consumption at Rated Load (m³/min)	Air Inlet Size BSP	Sound Pressure ⁽²⁾ (dbA)	System Weight ⁽³⁾ (kg)	Chain Size (mm)
ULBS100LC2A4	100	4	615	1.4	3	1.65	20	20	1-1/2"	93	8000	22x66
ULBS150LC2A6	150	6	731	0.9	2.2	1.1	20	20	1-1/2"	93	11000	22x66
ULBS200LC2A8	200	8	377	0.8	1.5	1	20	20	1-1/2"	93	12400	22x66
ULBS250LC2A10	250	10	905	0.55	1.2	0.8	20	20	1-1/2"	93	17000	22x66

ULBS ULTRA-LOW HEADROOM GEAR MOTOR SERIES - TROLLEY SUB-ASSEMBLY

MODEL	Number of Wheels per Hoist	Standard Flange Adjustment "X" (mm)	Max Beam Bottom Flange Thickness (mm)	Wheel Tread Diameter (mm)	Wheel Loading per Pair (kg)	Trolley Assy Length (mm)	Number of Motors per Trolley	Trolley Air Consumption per Hoist (m³/min)	Max Traveling Speed at Rated Load ⁽⁴⁾ (m/min)
ULBS100LC2A4	8	270-314	76	225	18750	2660	2	3.8	9
ULBS150LC2A6	16	200-314	76	225	9375	3578	4	7.6	12
ULBS200LC2A8	16	200-314	76	225	12500	3194	4	7.6	12
ULBS250LC2A10	16	200-360	102	250	15625	3600	4	7.6	9

(1) Minimum headroom shown is with Clevis option.
 (2) Sound pressure levels are measured per European Standard EN14492-2.
 (3) Weight of the complete system (2 hoists) with standard height of lift and length of control (9m).
 (4) In Rack & pinion configuration, the trolley speed is divided by 2

AIR MOTOR MODELS

Options and Accessories

Ingersoll Rand® has developed a large range of options and pneumatic accessories to provide you a key on hand solution.

CONTROLS

When the BOP system has to be installed on a bi-directional bridge crane, the PHS6 pendant allows the full control of the 3 movements. The progressive control levers provides an exceptional variable speed control of the load. Various versions are available to meet CE and ATEX requirements.

The Accu-trol™ pendant is an alternative to the standard PHS pendant, offering a vertical arrangement of the control buttons in a fully enclosed impact resistant frame.

Available with up to three functions (6 motions), and optional emergency stop button with CE version.

Ingersoll Rand can also offer standing control console for remote control of 2 or more hoists. From the instrument panel, each hoist can be run individually and an additional joystick allows the operator to simultaneously control a group of hoists.

Emergency stop buttons are fitted as standard on CE version.



PHS6E-U Pendant,
CE Version



Accu-Trol Pendant,
Non-CE Version



Control Console for Four
Hoists, CE Version

AIR SUPPLY

Air hose kits of different sizes and lengths can be ordered with your hoists system to create a supply line. The kit include the high quality hose and end fittings to connect to the hoist inlet and the supply source.

Festooning trolleys will support the air hose on the travelling beam; number of trolleys has to be determined with your Ingersoll Rand representative depending on the travel length and the loop height.

Specific models are available for ATEX zone 1 areas.

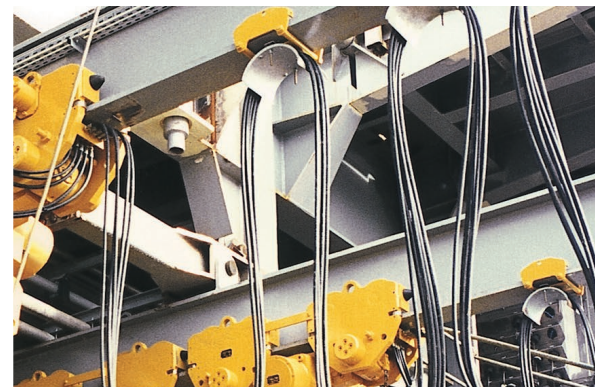

Typical Air Supply System

AIR MOTOR MODELS

HOW TO ORDER

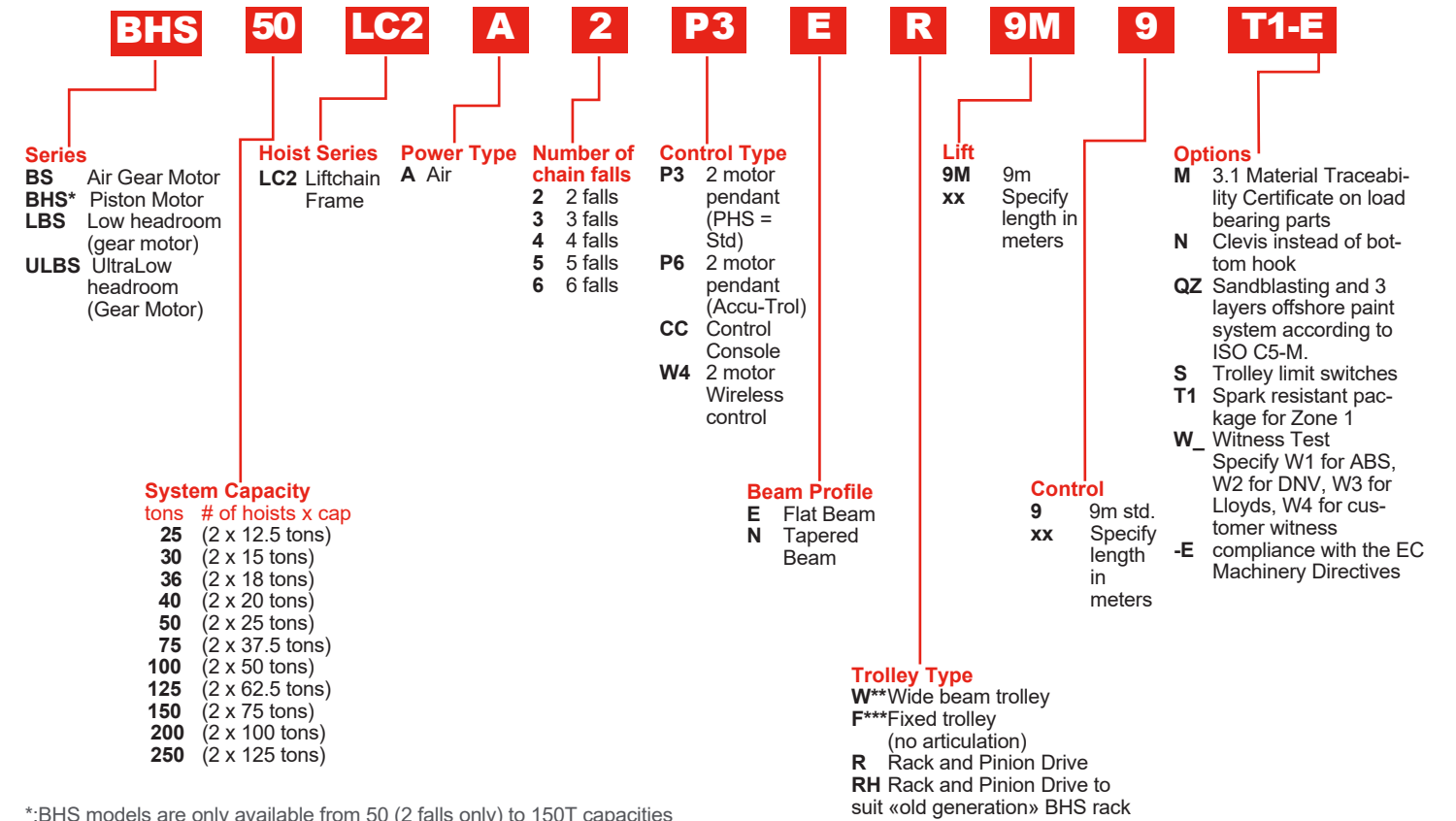

*:BHS models are only available from 50 (2 falls only) to 150T capacities
**.:Option «W» (Wide beam trolley) is not compatible with fixed trolley version option «F»
***.:Absence of «F» suffix implicates articulated trolley as standard on BS and BHS series

When ordered with “-E” option, Ingersoll Rand BOP systems are fitted with the additional following equipment:

- Built-in overload protection
- Emergency stop button on pendant
- CE marking and UE declaration of conformity
- ATEX marking and certificate



BS SERIES HYDRAULIC MOTOR

The LIFTCHAIN® Hydraulic Chain Hoist series is an innovative alternative to our air driven chain hoists. With a very low noise level, Ingersoll Rand® Hydraulic BOP Systems provides extremely sensitive variable speed control of lifting and travelling motions combined with a very low noise level.

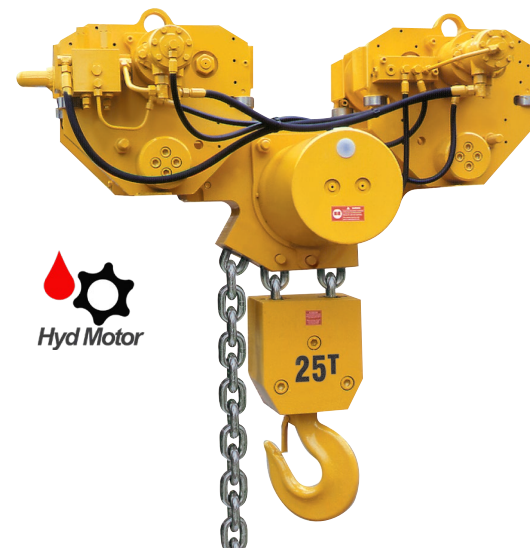

- Piston or orbital hydraulic motor on hoist and trolley
- 5:1 design factor
- All steel/cast iron construction
- Automatic Fail Safe multi disc brake on hoist and trolley
- Articulated trolley allows limited side pulling operations
- Fully enclosed planetary gear box

Specifications as per European standard EN14492-2 - Group of Mechanism FEM 1Bm / ISO M3

BS HYDRAULIC MOTOR SERIES - HOIST SUB-ASSEMBLY

MODEL	System Capacity (T)	Falls of Load Chain Per Hoist	Min. Headroom (mm)	Lifting Speed at Rated Load (m/min)	Lifting Speed at No Load (m/min)	Lowering Speed at Rated Load (m/min)	Working Pressure (bar)	Calibration Pressure (bar)	Nominal Flow (l/min)	System Weight ⁽¹⁾ (kg)	Chain Size (mm)
BS25LC2H2	25	2	1135	1.9	1.9	1.9	125	170	40	1000	16x45
BS30LC2H3	30	3	1210	1.25	1.25	1.25	145	175	40	1700	16x45
BS36LC2H3	36	3	1210	1.25	1.25	1.25	145	175	40	1700	16x45
BS40LC2H4	40	4	1240	1.1	1.1	1.1	145	175	40	1850	16x45
BS50LC2H4	50	4	1240	1.1	1.1	1.1	145	175	40	1850	16x45
BS50LC2H2	50	2	1043	2.25	2.25	2.25	175	210	50	3100	22x66
BS75LC2H3	75	3	1190	1.5	1.5	1.5	180	210	50	3900	22x66
BS100LC2H4	100	4	1232	1.1	1.1	1.1	185	210	50	4100	22x66
BS125LC2H5	125	5	1385	0.9	0.9	0.9	190	220	50	5900	22x66
BS150LC2H6	150	6	1520	0.75	0.75	0.75	195	220	50	6300	22x66
BS150LCH3	150	3	1865	0.48	0.48	0.48	150	210	40	12800	32x90
BS200LCH4	200	4	1960	0.35	0.35	0.35	180	210	50	13100	32x90

BS HYDRAULIC MOTOR SERIES - TROLLEY SUB-ASSEMBLY

MODEL	Number of Wheels per Hoist	Standard Flange Adjustment (mm)	Max Beam Bottom Flange Thickness (mm)	Wheel Tread Diameter (mm)	Wheel Loading per Pair (kg)	Trolley Assy Length (mm)	Number of Motors per Trolley	Max Traveling Speed at Rated Load ⁽²⁾ (m/min)
BS25LC2H2	4	160-314	40	160	6250	622	1	12
BS30LC2H3	4	160-314	40	225	7500	782	1	12
BS36LC2H3	4	160-314	40	225	9000	782	1	12
BS40LC2H4	4	160-314	40	225	10000	782	1	12
BS50LC2H4	4	160-314	40	225	12500	782	1	12
BS50LC2H2	8	160-314	40	160	6250	1412	1	10
BS75LC2H3	8	160-314	40	225	9375	1692	2	15
BS100LC2H4	8	160-314	40	225	12500	1692	2	15
BS125LC2H5	8	160-360	102	250	15625	2060	2	9
BS150LC2H6	8	160-360	102	250	18750	2060	2	9
BS150LCH3	16	150-314	40	225	9375	3394	4	10
BS200LCH4	16	170-314	40	225	12500	3394	4	10

(1) Weight of the complete system (2 hoists) with standard height of lift and length of control (9m)

(2) In Rack & pinion configuration, the trolley speed is divided by 2

LBS SERIES HYDRAULIC MOTOR

Low Headroom Models

Ingersoll Rand® Low Profile BOP Handling Systems feature the same reliable operation and durable construction while providing even more clearance for BOP stack operation. Spark resistant, ATEX Zone 1 packages are available.

Operated from a console, a remote joystick or a wireless system, it's the preferred choice of many rig builders for their performance and level of safety.

- Piston or orbital hydraulic motor on hoist and trolley
- 5:1 design factor
- -20°C design temperature
- All steel/cast iron construction
- Automatic Fail Safe multi disc brake on hoist and trolley
- Fully enclosed planetary gear box



Complete your installation by selecting Ingersoll Rand accessories or options and get a key on hand system.

Specifications as per European standard EN14492-2 - Group of Mechanism FEM 1Bm / ISO M3

LBS HYDRAULIC MOTOR SERIES - HOIST SUB-ASSEMBLY

MODEL	System Capacity (T)	Falls of Load Chain Per Hoist	Min. Headroom (mm)	Lifting Speed at Rated Load (m/min)	Lifting Speed at No Load (m/min)	Lowering Speed at Rated Load (m/min)	Working Pressure (bar)	Calibration Pressure (bar)	Nominal Flow (l/min)	System Weight ⁽¹⁾ (kg)	Chain Size (mm)
LBS24LC2H2	24	2	670	2.8	2.8	2.8	130	175	48	1350	16x45
LBS36LC2H3	36	3	730	1.85	1.85	1.85	150	175	48	1650	16x45
LBS50LC2H4	50	4	775	1.4	1.4	1.4	150	175	48	1750	16x45

LBS LOW HEADROOM HYDRAULIC MOTOR SERIES - TROLLEY SUB-ASSEMBLY

MODEL	Number of Wheels per Hoist	Standard Flange Adjustment "X" (mm)	Max Beam Bottom Flange Thickness (mm)	Wheel Tread Diameter (mm)	Wheel Loading per Pair (kg)	Trolley Assy Length (mm)	Number of Motors per Trolley	Max Traveling Speed at Rated Load ⁽²⁾ (m/min)
LBS24LC2H2	4	140-314	40	160	6000	1164	1	15
LBS36LC2H3	4	170-314	40	225	9000	1164	1	15
LBS50LC2H4	4	170-314	40	225	12500	1164	1	15

(1) Weight of the complete system (2 hoists) with standard height of lift and length of control (9m).

(2) In Rack & pinion configuration, the trolley speed is divided by 2

ULBS SERIES HYDRAULIC MOTOR

Ultra-Low Headroom Models

The BS Series BOP Handling Systems can be designed in ultra-low headroom version for applications requiring a very limited working height — range of capacities from 100 to 250T. The minimum headroom of these products is only slightly greater than the size of the bottom hook assembly.

Note: the very compact design of the ULBS Series does not allow an articulated connection between the trolley and hoist.

- Piston or orbital hydraulic motor on hoist and trolley
- 5:1 design factor
- All steel/cast iron construction
- Automatic Fail Safe multi disc brake on hoist and trolley
- Fully enclosed planetary gear box



ULBS150 Factory Acceptance Test

Specifications as per European standard EN14492-2 - Group of Mechanism FEM 1Bm / ISO M3

ULBS ULTRA LOW HEADROOM HYDRAULIC MOTOR SERIES - HOIST SUB-ASSEMBLY

MODEL	System Capacity (T)	Falls of Load Chain Per Hoist	Min. Headroom ⁽¹⁾ (mm)	Lifting Speed at Rated Load (m/min)	Lifting Speed at No Load (m/min)	Lowering Speed at Rated Load (m/min)	Working Pressure (bar)	Calibration Pressure (bar)	Normal Flow (l/min)	System Weight ⁽²⁾ (kg)	Chain Size (mm)
ULBS100LC2H4	100	4	615	2.3	2.3	2.3	170	200	100	8000	22x66
ULBS150LC2H6	150	6	731	1.4	1.4	1.4	175	210	100	11000	22x66
ULBS200LC2H8	200	8	377	0.9	0.9	0.9	180	210	100	12400	22x66
ULBS250LC2H10	250	10	905	0.7	0.7	0.7	185	210	100	17000	22x66

ULBS ULTRA LOW HEADROOM HYDRAULIC MOTOR SERIES - TROLLEY SUB-ASSEMBLY

MODEL	Number of Wheels per Hoist	Standard Flange Adjustment (mm)	Max Beam Bottom Flange Thickness (mm)	Wheel Tread Diameter (mm)	Wheel Loading per Pair (kg)	Trolley Assy Length (mm)	Number of Motors per Trolley	Max Traveling Speed at Rated Load ⁽³⁾ (m/min)
ULBS100LC2H4	8	160-360	76	225	12500	2660	2	9
ULBS150LC2H6	16	185-314	76	225	9375	3578	4	12
ULBS200LC2H8	16	160-314	76	225	12500	3194	4	12
ULBS250LC2H10	16	160-360	102	250	15625	3600	4	9

⁽¹⁾ Minimum headroom shown is with Clevis option

⁽²⁾ Weight of the complete system (2 hoists) with standard height of lift and length of control (9m)

⁽³⁾ In Rack & pinion configuration, the trolley speed is divided by 2

HYDRAULIC MOTOR MODELS

Options and Accessories

Our Hydraulic BOP Handling Systems can benefit of many options and accessories to suit your application.

Ingersoll Rand® Hydraulic BOP Systems can be delivered with a full flow control, meaning that up-down and forward reverse commands are coming directly from an independent control panel of the rig.

This type of control is recommended when the operator has the manage various machines from a unique control room.

The pendant joystick control allows the operator to manage the various motions from a single throttle lever. On CE versions a side 1/4 turn valve can shut down the system for emergency stop.

When used on floating installations with potential harsh weather, BOP handling systems can be offered with an optional rack and pinion drive system on trolleys in order to provide exact positioning when operating. The Ingersoll Rand design underneath the beam will ensure a long life to the rack and pinion drive by reducing the risk of dust accumulation in the rack.

Control Console: Ingersoll Rand engineers have designed various remote control stations from where several hoists can be managed. Typical console includes several individual controls and one simultaneous control joystick to run a complete BOP hoists system.

Hose Kits: standard hose kits are made of several hoses with 316 stainless steel press fittings at each end, and a connecting manifold to be bolted on the beam end.

These hose kits exist for either full flow control or joystick pendant control versions.

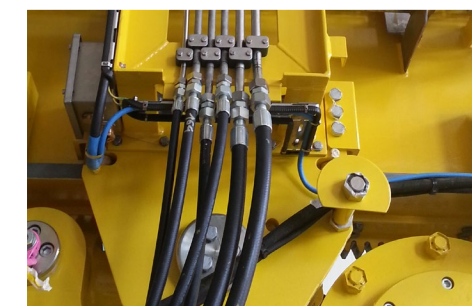
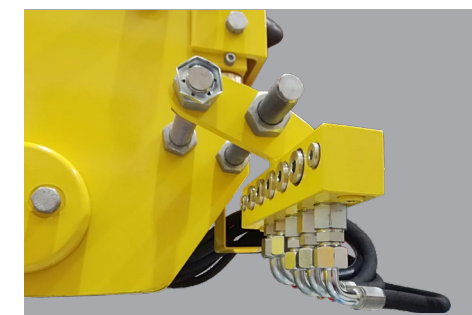

Options and Accessories (continued)

Festoon trolleys with either steel or bronze wheels (for ATEX Zone 1) to support hoses; number of festoon trolley has to be determined depending on the travel length and the possible loop maximum height. These trolleys are designed for long-life in harsh environment with following features:

- Galvanized steel large radius hose support
- Adjustable width up to 310mm
- Anti-kickback wheel
- Optional massive bronze wheels



HYDRAULIC MOTOR MODELS

HOW TO ORDER

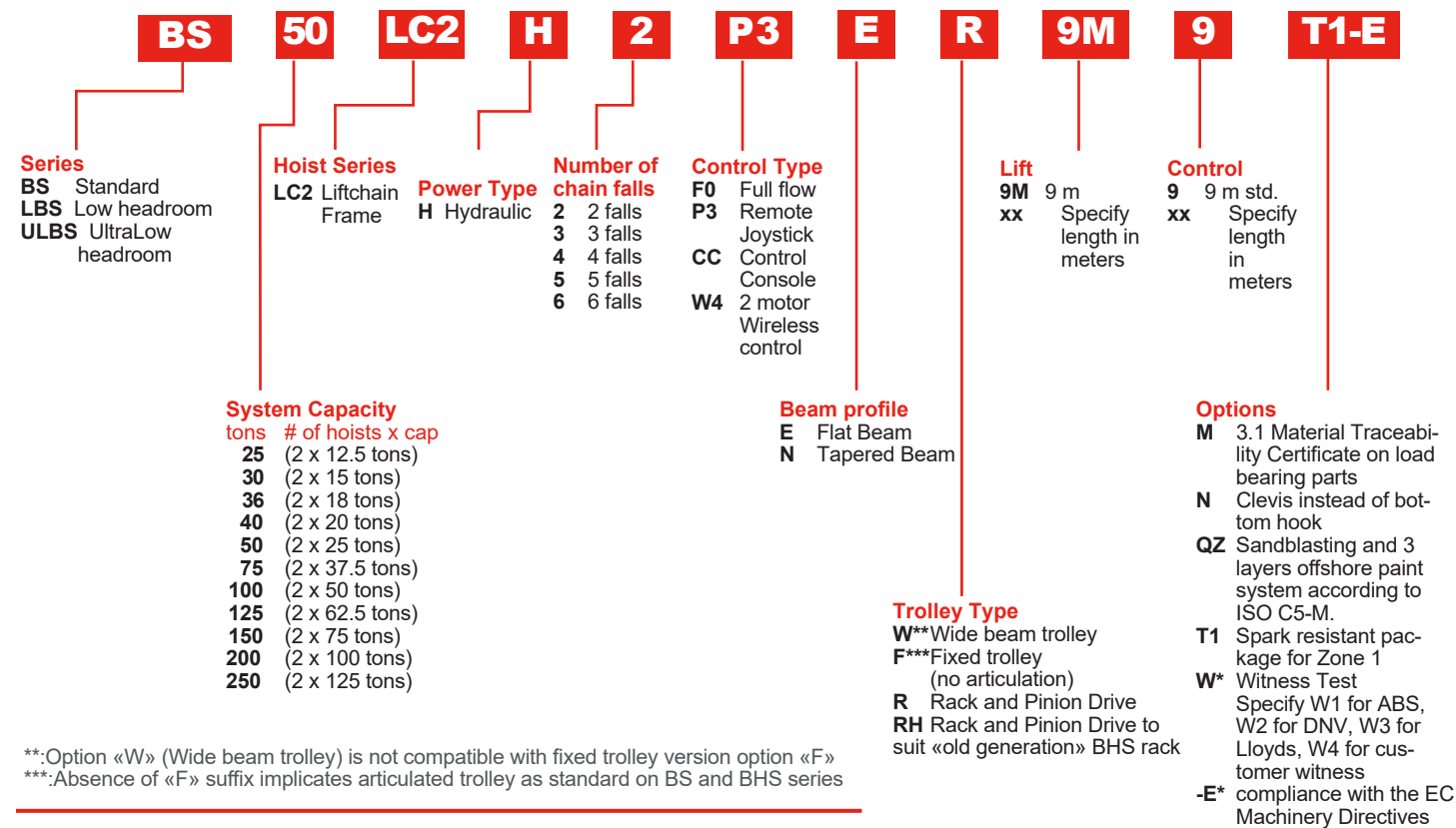

When ordered with “-E” option, Ingersoll Rand BOP systems are fitted with the additional following equipment:

- Built-in overload protection
- Emergency stop
- CE marking and UE declaration of conformity
- ATEX marking and certificate



* :Compliance with EC machinery directive is only available with «P3», «CC» and «W4» control options. «F0» full flow control models are delivered with an Incorporation certificate. the end user or integration company has to complete the control installation as per EC machinery directive and is responsible for EC certification.

CUSTOM DESIGN SOLUTIONS

Ingersoll Rand® specialists works in conjunction with the oil rig designers and users to provide the best solution for any specific situation.

Wireless Controls: we have delivered many wireless control systems to our customers with very specific features to match their expectations:

- 2 or 4 hoists control
- ATEX certified
- Simultaneous control
- Real load display



Retention Lug: this additional hanging point on the hoist trolley assembly allows to suspend the BOP stack for storage; while using the retention lug, the hoist drive and brake mechanism are not subject to vibrations under load tension; light maintenance operations can also be performed on the hoist while the BOP is secured using this lug.



Ultra-low Ambient Temperature Applications:

Extreme conditions are never a barrier for Ingersoll Rand engineers who can study very specific needs such a BOP handling Systems able to operate at -45°C ambient temperature.

A special design including Charpy test on primary load bearing components also includes a pre-heating system.



ENCOMPASS RECERTIFICATION PROGRAM

Blowout Preventer (BOP) Handling Systems are critical to your operation. Encompass is designed to prolong the life of this equipment and ensure it runs safely when you need it by streamlining start-up, inspection, maintenance and overhaul processes. In addition to extending your warranty, you'll benefit from reduced costs related to unplanned repairs and improved productivity.



Encompass BOP Handling System Service Timeline

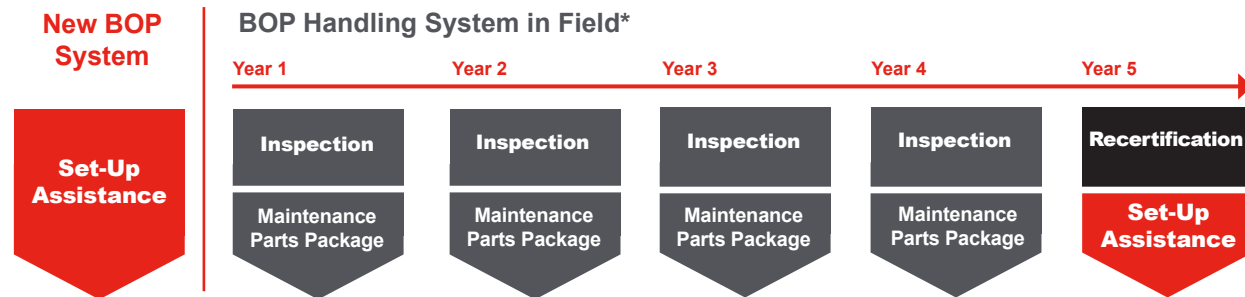

*For units currently in the field, the program should start at the appropriate year of service relative to the time the unit has been in operation.



Start-Up Assistance

An Authorized Service Provider will assist you throughout the entire start-up process: review for proper installation, initial operational checks, load testing and functional testing. We'll back-up our work with an 18-month warranty — an additional 6 month extension beyond the standard product warranty.



Certified Spare Parts

Purchase the Ingersoll Rand 2-year maintenance parts package to ensure equipment uptime is maximized. We will extend your equipment's warranty for an additional 6 months with the purchase of these certified parts.



Inspections

Through the Encompass program, inspections are performed exclusively by Ingersoll Rand Authorized Service Providers using parameters customized for your equipment. Results are provided in an official certificate, and you'll receive an Encompass seal for your equipment to indicate an authorized inspection.



Recertification

We'll bring your lifting equipment back to life with a full-unit overhaul. Upon completion, your equipment is warranted for a full year, and includes a certificate of work and authorized overhaul nameplate.

With the Encompass seal on your equipment, you'll have peace of mind knowing it's been inspected by an Authorized Service Distributor.



TROLLEY SELECTION

Using the right trolley size is crucial for your installation. Ingersoll Rand® has created 2 trolley sizes in order to match any configuration, even with very large structural beams, solution for any specific situation.

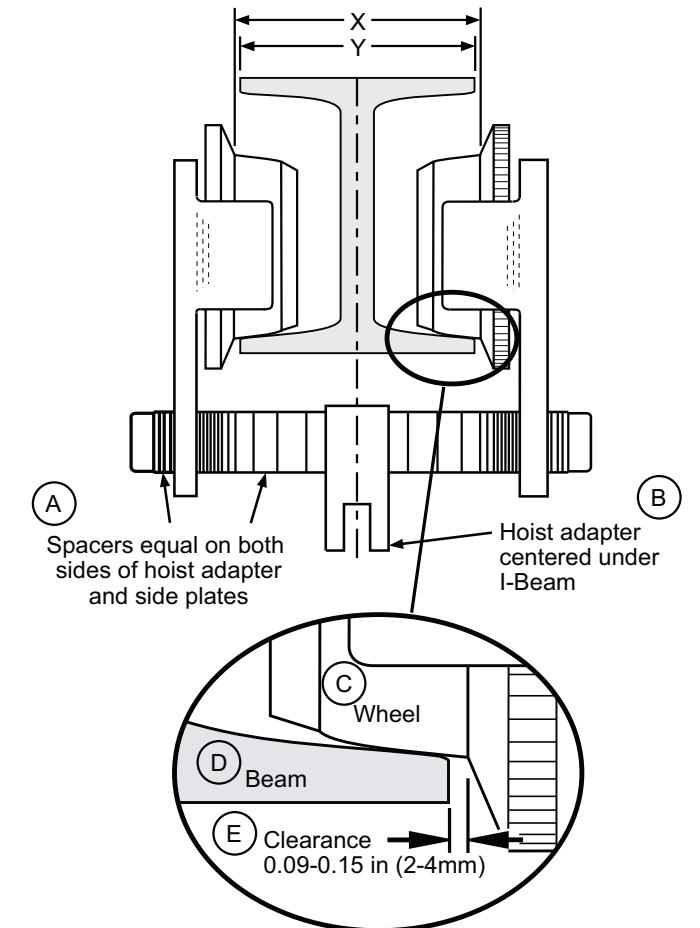
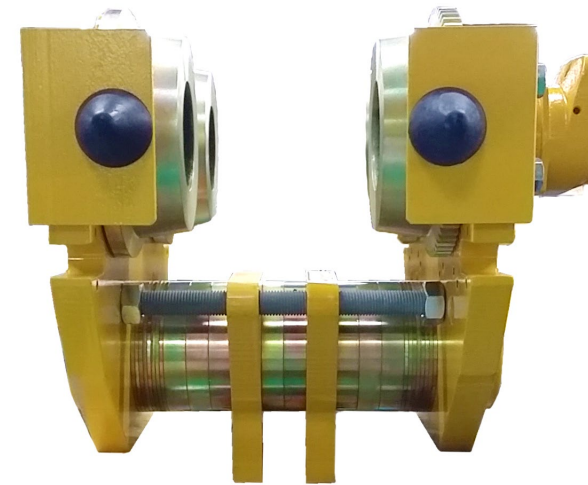

Flange adjustment : $X = Y + 2 * E$

To select the correct trolley size, you need to check if your theoretical beam size "Y" plus the clearance "E" on each side of the beam is compatible with the flange adjustment range "X" shown in the standard models specification tables.

For very large beams sizes, an optional wide beam flange adjustment (option "W") can be ordered. Please refer to the How to order pages.





Wide trolley option «W» is not compatible with fixed trolley versions option «F»

SELECTION CHART

Series	Capacity (T)	Flange Adjustment "X" (mm)		Maximum Bottom Flange Thickness (mm)
		Standard	Wide (Option "W")	
BS	25	130-314	315-410	40
BS	25 / 30 / 36 / 40 / 50 (4 falls)	140-314	315-410	40
BS / BHS	50 (2 falls) / 75 / 100	160-314	315-410	40
BS / BHS	125 / 150 (6 falls)	160-360	365-410	102
BS	150 (3 falls) / 200	170-314	315-410	40
LBS	24	170-314	315-410	40
LBS	36 / 50	170-314	315-410	40
ULBS	100	270-314	315-410	40
ULBS	150 / 200	200-314	315-410	40
ULBS	250	200-360	365-410	102



STANDARD MODELS QUICK SELECTION CHART

AIR MOTOR DRIVE

System Capacity (T)	Model Number	Falls of Load Chain per Hoist	Min. Headroom (mm)	Lifting Speed at Rated Load (m/min)	Motor Type	
BS Series - Standard models (Gear motor)						
25	BS25LC2A2	2	1135	1		
30	BS30LC2A3	3	1210	0.8		
36	BS36LC2A3	3	1210	0.7		
40	BS40LC2A4	4	1240	0.6		
50	BS50LC2A4	4	1240	0.5		
50	BS50LC2A2	2	1043	1.6		
75	BS75LC2A3	3	1190	1.1		
100	BS100LC2A4	4	1232	0.8		
125	BS125LC2A5	5	1385	0.64		
150	BS150LC2A6	6	1520	0.53		
150	BS150LCA3	3	1865	0.35		
200	BS200LCA4	4	1960	0.25		
BHS Series - Standard models (Piston motor)						
50	BHS50LC2A2	2	1043	1.2		
75	BHS75LC2A3	3	1190	0.8		
100	BHS100LC2A4	4	1232	0.6		
125	BHS125LC2A5	5	1385	0.5		
150	BHS150LC2A6	6	1520	0.4		
LBS Series - Low Headroom models (Gear motor)						
24	LBS24LC2A2	2	670	1.1		
36	LBS36LC2A3	3	730	0.7		
50	LBS50LC2A4	4	775	0.5		
ULBS Series - Ultra-Low Headroom models (Gear motor)						
100	ULBS100LC2A4	4	615	1.4		
150	ULBS150LC2A6	6	731	0.9		
200	ULBS200LC2A8	8	377	0.8		
250	ULBS250LC2A10	10	905	0.55		

STANDARD MODELS QUICK SELECTION CHART

HYDRAULIC MOTOR DRIVE

System Capacity (T)	Model Number	Falls of Load Chain per Hoist	Min. Headroom (mm)	Lifting Speed at Rated Load (m/min)	Motor Type	
BS Series - Standard models (Hydraulic motor)						
25	BS25LC2H2	2	1135	1.9		
30	BS30LC2H3	3	1210	1.25		
36	BS36LC2H3	3	1210	1.25		
40	BS40LC2H4	4	1240	1.1		
50	BS50LC2H4	4	1240	1.1		
50	BS50LC2H2	2	1043	2.25		
75	BS75LC2H3	3	1190	1.5		
100	BS100LC2H4	4	1232	1.1		
125	BS125LC2H5	5	1385	0.9		
150	BS150LC2H6	6	1520	0.75		
150	BS150LCH3	3	1865	0.48		
200	BS200LCH4	4	1960	0.35		
LBS Series - Low Headroom models (Hydraulic motor)						
24	LBS24LC2H2	2	680	2.8		
36	LBS36LC2H3	3	729	1.85		
50	LBS50LC2H4	4	818	1.4		
ULBS Series - Ultra-Low Headroom models (Hydraulic motor)						
100	ULBS100LC2H4	4	615	2.3		
150	ULBS150LC2H6	6	731	0.8		
200	ULBS200LC2H8	8	377	0.8		
250	ULBS250LC2H10	10	905	0.7		



Ingersoll Rand (NYSE:IR), driven by an entrepreneurial spirit and ownership mindset, is dedicated to helping make life better for our employees, customers and communities. Customers lean on us for our technology-driven excellence in mission-critical flow creation and industrial solutions across 40+ respected brands where our products and services excel in the most complex and harsh conditions. Our employees develop customers for life through their daily commitment to expertise, productivity and efficiency.



Learn more at www.ingersollrand.com